



VIBRATION ANALYSIS HARDWARE



**JB110 Series Switch Box
4-12 Channel
Product Manual**

TABLE OF CONTENTS

- Introduction.....3
- Product Description.....3
- Product Dimensions.....4
- Mounting Instructions.....5
- Conduit Entry6
- Grounding.....7
- Sensor Installation9
- Post Installation Testing 12
- Maintenance 13
- Warranty & Refund 14



INTRODUCTION

CTC switch box solutions allow for the monitoring of remotely mounted vibration sensors, which would otherwise be restricted to human access due to safety considerations.

JB110 Series Switch Box Overview: 4-12 channel boxes, fiberglass enclosure

The JB110 Switch Boxes are a common cable termination point for bringing compatible cables for sensors, proximity probes, and temperature probes into a switch box for routine data collection with portable data collectors. JB series enclosures are designed to have field input cabling installed behind the board. A flip-down panel allows the user to wire connections on location. The JB series also features an IEPE bias indicator light built into the box itself, which can be used to indicate errors in the field wiring or the sensor.

Rated for NEMA 4X (IP66), the JB110 is resistant to hose directed fluid and corrosion. The box can also withstand harsh environments, including temperatures ranging from -58 to 180 °F (-50 to 82 °C). A snap latch is installed on the door, allowing the box to be sealed from the elements when not in use.

If a continuous output application is desired that can be easily accomplished by purchasing the optional CTC accessory "T" plug part number JB907-3A.



PRODUCT DIMENSIONS

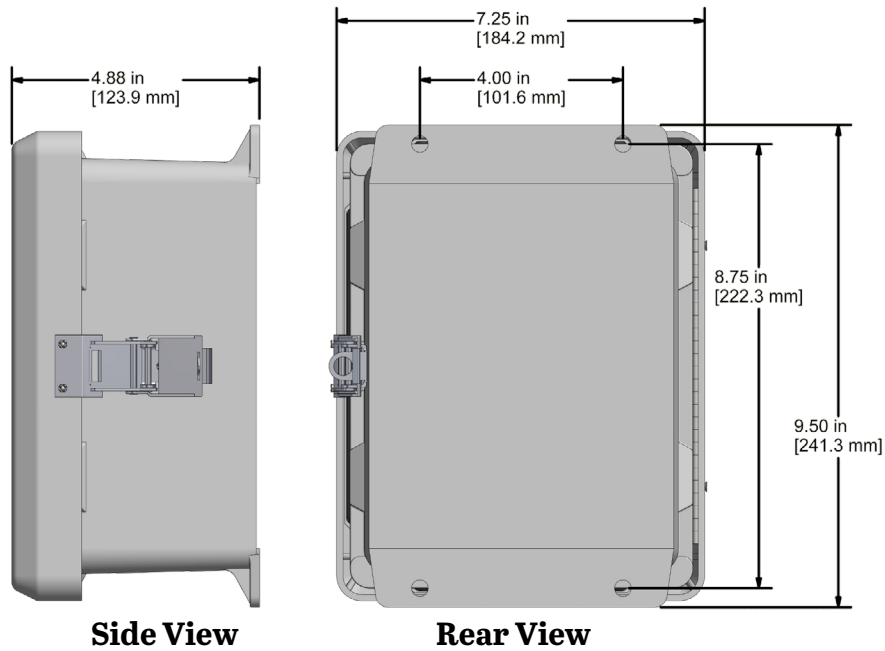

Figure 1. Dimensions

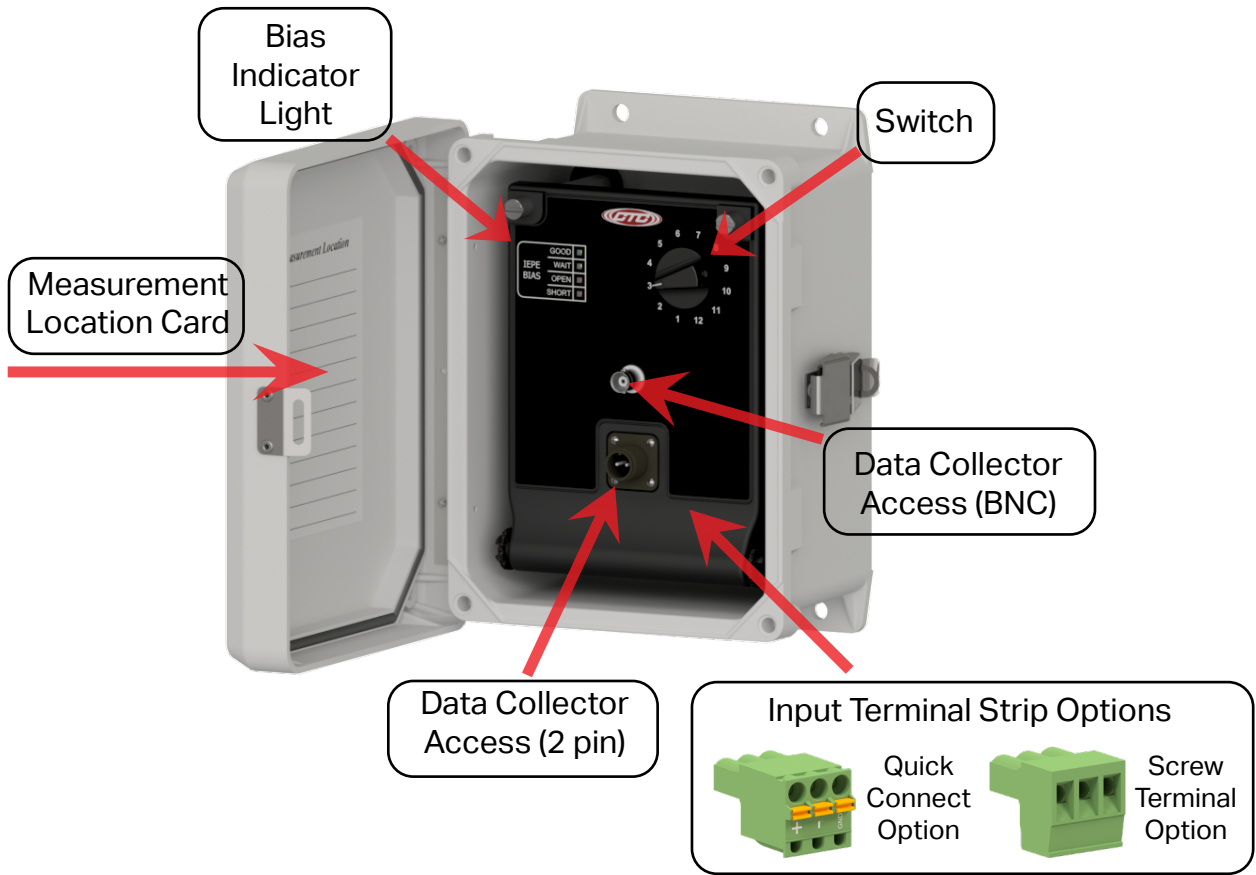

Figure 2. Diagram



MOUNTING INSTRUCTIONS

Molded mounting brackets are included on the enclosure. Wall anchoring screws are not included.

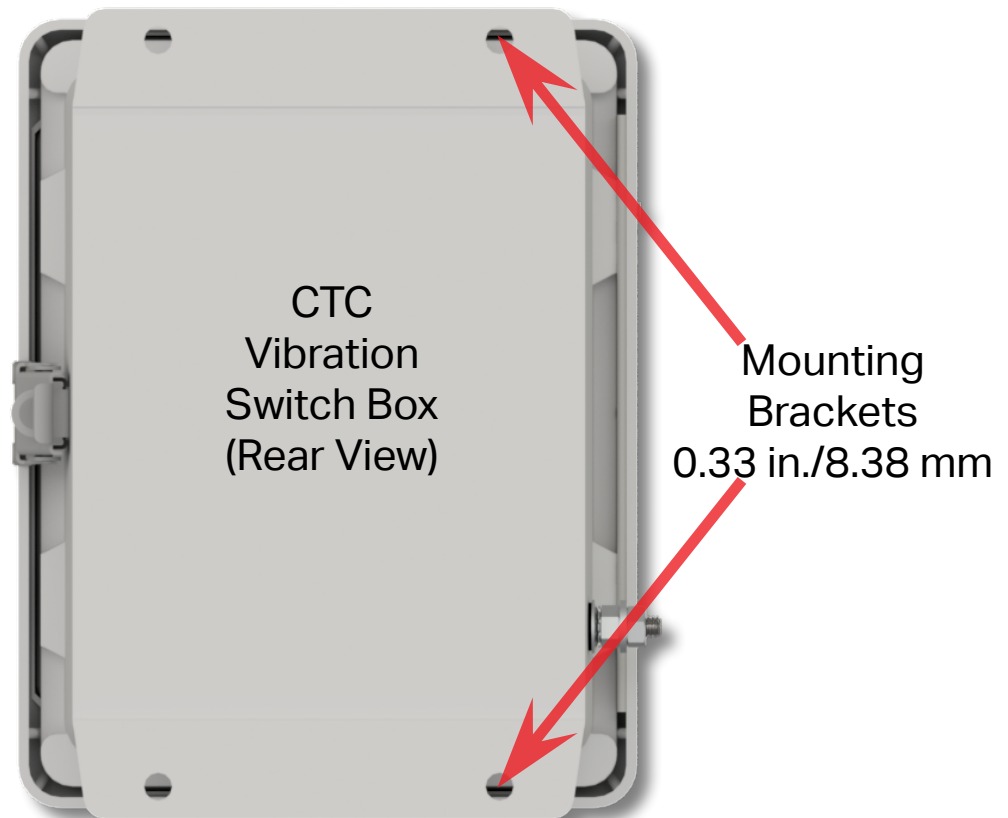

Figure 3. Mounting Bracket Placement

CONDUIT ENTRY

If you have purchased a switch box without cable entries provided, you should add your own entry prior to mounting the enclosure. CTC does not recommend putting holes in the top of enclosures as it will cause restricted access to the wire termination connection points and also allow possible moisture ingress.

Note: To prevent a buildup of condensation inside the enclosure, provide drainage by drilling a hole in the lowest point of the conduit.

Correct

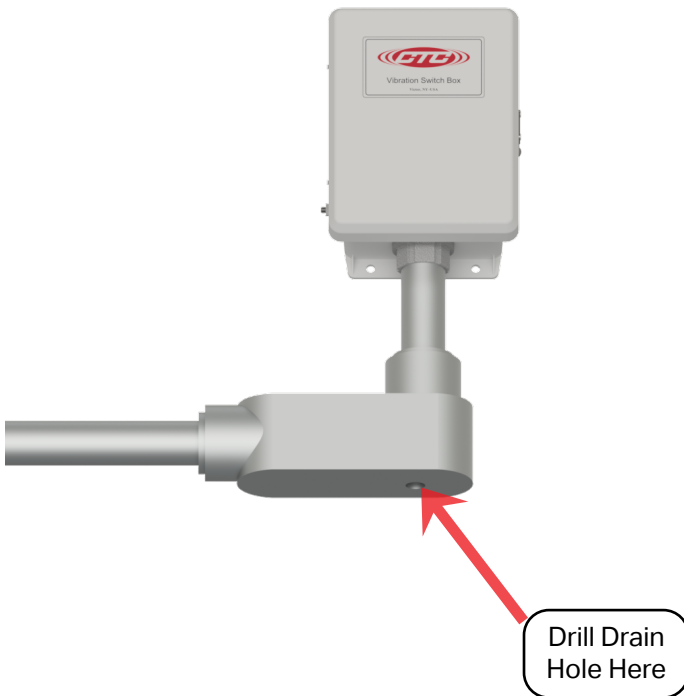

Incorrect

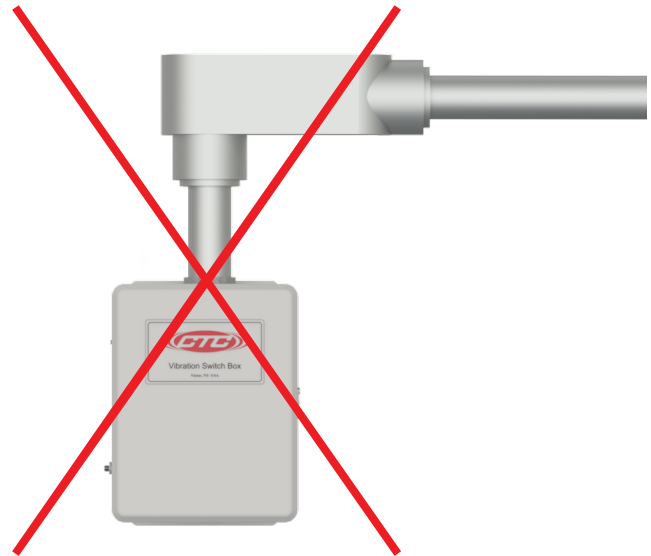

Figure 4. Conduit Entry for Switch Box

GROUNDING

Ensure the shield ground wire on the JB110 Series Switch Boxes is grounded to earth ground.

A. Mounting to Earth Ground

When mounting JB110 Series Switch boxes to earth ground (such as an I-Beam), mount the shield ground wire using a mounting bolt through one of the mounting brackets on the enclosure. See Figure 5 below.



Figure 5. Proper Shield Grounding Technique

GROUNDING

B. Mounting to non-grounded structure

When mounting the switch box to a non-grounded structure, ensure the shield ground wire or customer supplied ground wire is tied to a source of earth ground.



Figure 6. Ground Wire Placement

SENSOR INSTALLATION

Installation of sensors/signal input cable

1. Feed blunt cut end through the cable entry at the bottom of the enclosure.

Note: it is recommended that cables are marked on both ends.

For cord grip cable entry, take off the cord grip cover with bushing and run cable through it then into the enclosure, hand tighten cord grip cover to base to prevent damage of cord grip.



Figure 7. Front View



Figure 8. Bottom View with Cord Grips Installed

1. Strip outer jacket of cable back 1¼ in. and remove all of the shielding.
2. Separate the internal wires from the shield.
3. Strip red and black insulation back ¼ in.

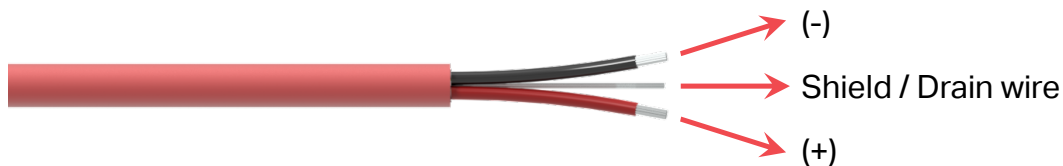
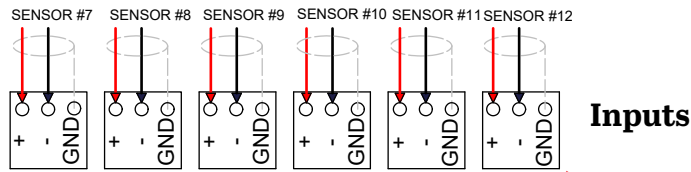
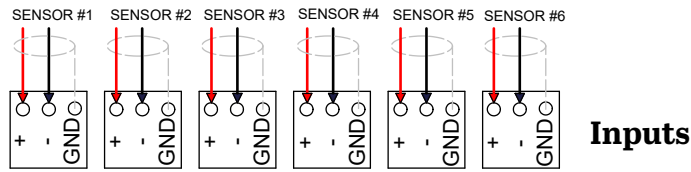

Figure 9. Stripped Wire

SENSOR INSTALLATION

4. Locate the appropriate plug (identified by channel number), remove it, and install the wires using a small flathead screwdriver. Push plug back into location. Orientation is as follows:
 - a. Red insulated conductor wire is connected to (+).
 - b. Black insulated conductor wire is connected to (-).
 - c. Shield drain wire is connected to ground (GND).
 - d. Depress selected position button to open terminal for respective wire (may require a mini flat head screwdriver).



Sensor Inputs
Red = Positive
Black = Common
Grey = Shield (Ground)

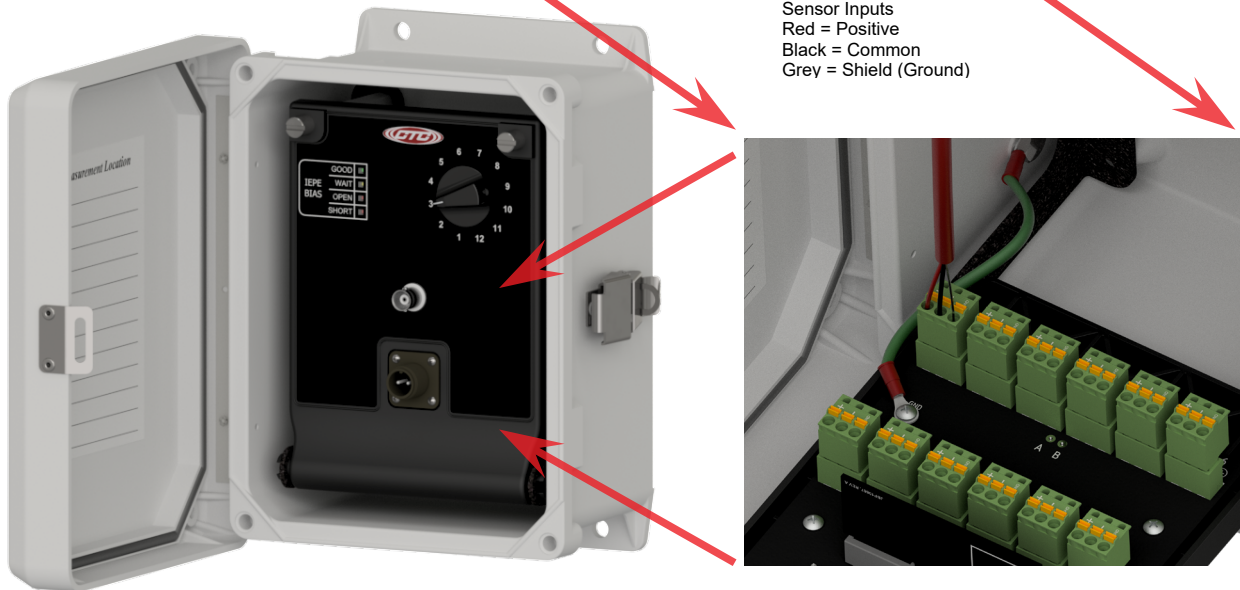

Figure 10. Field Wiring for 2-Conductor Sensor Inputs

SENSOR INSTALLATION

- 5. Insert plug into the appropriate PC board connector and double check to ensure that the cable is going to the correct channel.

Note: If your application requires continuous output, the wiring configuration for the JB110 is slightly modified.

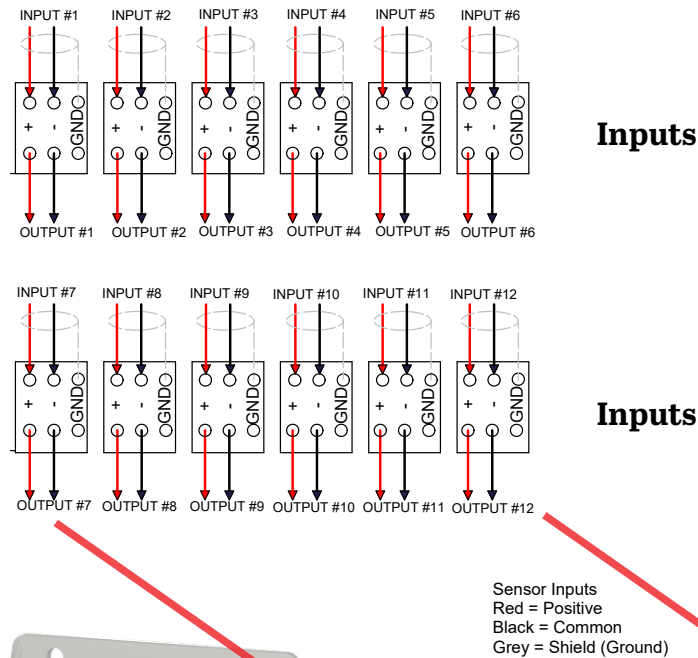

Figure 11. Field Wiring for Continuous Output

- 6. Mark the Measurement Location Card located on the inside front cover with a description of each measurement location.

POST INSTALLATION TESTING

The TM1018 Accelerometer Verification Meter can be used to verify cable conductivity, sensor location and proper wiring connections. The Verification Meter will indicate if the sensor, cable and/or junction box is in working condition. It will also confirm bias voltage of the accelerometer, which will inform you of the operation of the internal accelerometer amplifier.

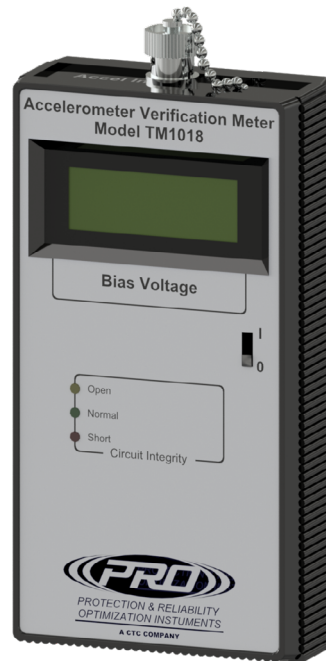

Figure 12. TM1018 Accelerometer Verification Meter

Testing Method:

1. Utilizing two personnel, Person A will be located at the switch box, while Person B will be located at the measurement location.
2. Once positioned, Person A will connect the TM1018 to the data collector output to the switch box and turn the Channel Selector to the channel that corresponds to the referenced measurement. Person A should observe a "NORMAL" LED reading.
3. Person B disconnects the cable from the accelerometer, and the TM1018 should respond with an "OPEN" LED. Reconnect the cable to the accelerometer, and the TM1018 should respond with a "NORMAL" LED.
4. Repeat for each measurement location to verify that accelerometer location is properly identified at the switch box.

POST INSTALLATION TESTING

The following LED Readout indicates the circuit integrity:

1. Green LED: Normal. Indicates proper connection and an output bias will be given, indicating the health of the sensor (4 – 16 V indicates a healthy accelerometer).
2. Yellow LED: Open Circuit. Indicates one of the following:
 - a. Cable connector is not connected to accelerometer.
 - b. Cable is open circuit (broken or not connected @ one end).
 - c. Accelerometer is not functioning correctly
3. Red LED: Short Circuit. Indicates one of the following:
 - a. Water or contamination in the connector.
 - b. Reverse Wiring ((+) and (-) leads are reversed) at terminal block inputs of the switch box.
 - c. Wires in switch box or cable connector (+) & (-) are touching.

MAINTENANCE

Once the system has been installed, it requires minimal maintenance. Basic checks to ensure system integrity should be made periodically.

Visual inspection should include examinations for the following:

1. No Visible electrical burns or smoke inside the enclosure
2. Enclosure hinges are free from rust and securely latched
3. No moisture or condensation is present inside the enclosure



WARRANTY & REFUND

Warranty

All CTC products are backed by our unconditional lifetime warranty. If any CTC product should ever fail, we will repair or replace it at no charge.

Refund

All stock products qualify for a full refund if returned in new condition within 90 days of shipment. Build to order products qualify for a 50% refund if returned in new condition within 90 days of shipment. Custom products are quoted and built specifically to the requirements of the customer, which may include completely custom product designs or private labeled versions of standard products for OEM customers. Custom products ordered are non-cancellable, non-returnable and non-refundable.

