



VIBRATION ANALYSIS HARDWARE



**SCE200 Series Signal Conditioner Enclosure
4 Channel
Product Manual**

TABLE OF CONTENTS

- Introduction.....3
- Product Description.....3
- Product Dimensions & Diagram.....4
- Mounting Instructions.....5
- Conduit Entry6
- Grounding.....7
- Electrical Connections9
- Troubleshooting..... 12
- Warranty & Return Information 15



INTRODUCTION

This document contains information on the operation, installation and maintenance of the SCE Series Signal Conditioner Enclosure. This manual is an overview of the system and references the specific component manuals. User manuals are provided with the system for all configurable internal components.

Product Overview

The SCE Series Signal Conditioner Enclosure is a turnkey solution coming fully populated with signal conditioners, power supply, and terminal blocks for sensor wiring terminations. The signal conditioners are already pre-configured based on the customer's specific requirements. Terminal blocks are provided for your sensor terminations. These terminal blocks are pre-wired to the signal conditioners and outputs from the signal conditioners are wired to terminal blocks for integration into PLC/DCS systems. Each signal conditioner utilizes screw terminals for the various input/output options such as, ± 20 to 32 Vdc power input, \pm signal output (1-2 configurable vibration outputs [0 mA-20 mA, 4 mA-20 mA, 0-5 Vdc, 0-10 Vdc] and a temperature output in 0.1-1.7 Vdc) and \pm sensor input (vibration, displacement and temperature inputs). There is also a green indicator light (Transducer Signal OK) which illuminates when the sensor is properly connected to the transmitter and working correctly. The power supply accepts input voltage of 100-240 VAC, .68 A & 50-60 Hz and provides 24 Vdc to the signal conditioners and sensors. The power supply terminals include AC Input Terminals (L) & (N), and Ground. DC Output Terminals are utilized in providing power to the vibration transmitters. The output voltage of the power supply is 21.6 – 26.4 VDC.

Refer to the [SC310 Series Signal Conditioner Product Manual](#) for specific electrical, performance, and calibration instructions.



PRODUCT DIMENSIONS

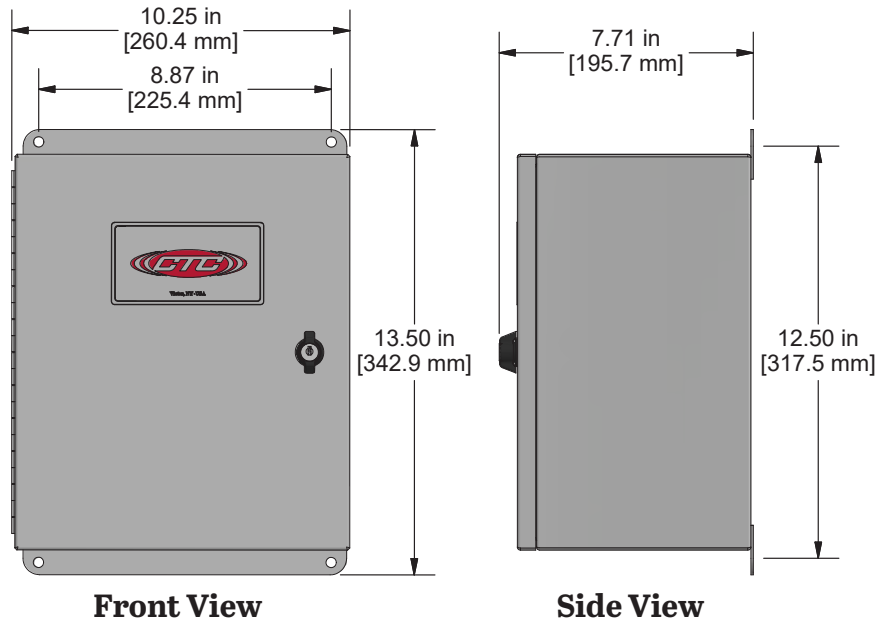

Figure 1. Dimensions



Figure 2. Diagram

MOUNTING INSTRUCTIONS

Stainless steel mounting brackets are included on the enclosure. Wall anchoring screws are not included. **Note:** if you have purchased a SCE200 series enclosure without cable entries provided, you should add your own entry prior to mounting the enclosure. CTC does not recommend putting holes in the top of the enclosure due to access and moisture concerns.

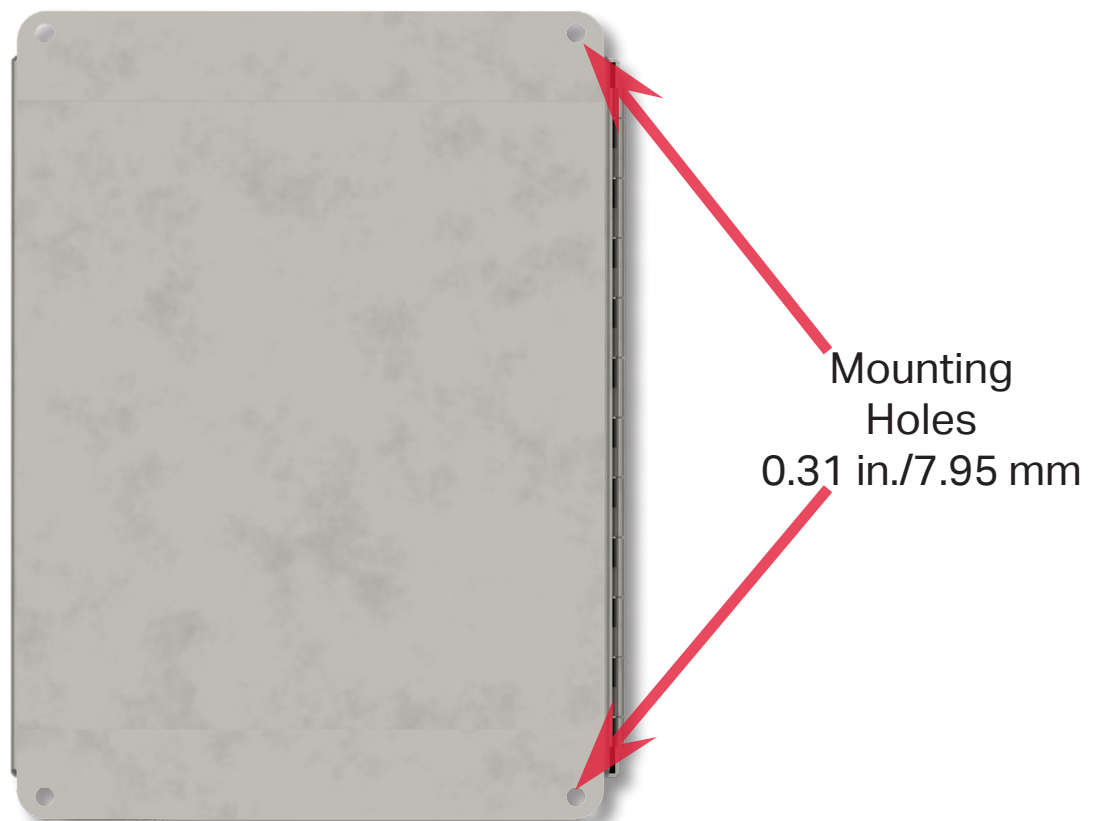

Figure 3. SCE200 Series Rear View

CONDUIT ENTRY

If you are running conduit to your enclosure, ensure the conduit cable entry enters from the bottom of the enclosure when mounted.

Note: To ensure moisture will not flow into the enclosure, a hole should be drilled at the lowest point in the conduit to provide drainage for any moisture.

Correct

Incorrect

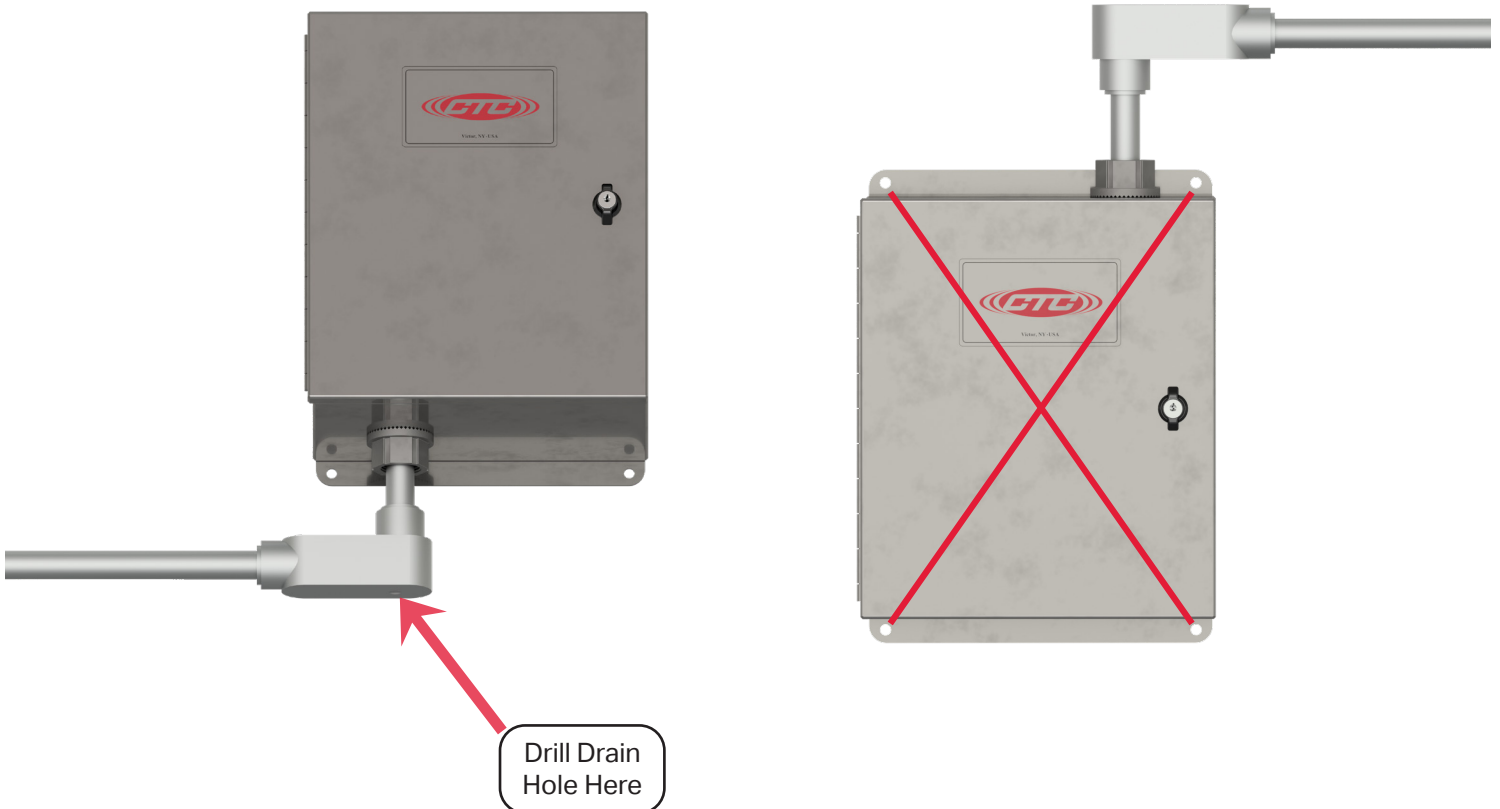

Figure 4. Conduit Entry for SCE200 Series

GROUNDING

Ensure the shield ground wire on the SCE200 Series enclosure is grounded to earth ground.

A. Mounting to Earth Ground

When mounting SCE200 Series enclosures to earth ground (such as an I-Beam), no additional steps are necessary, as the enclosure is grounded internally.



Figure 5. Proper Shield Grounding Technique

B. Mounting to non-grounded structure

When mounting the SCE200 series enclosure to a non-grounded structure, ensure the shield ground wire or customer supplied ground wire is tied to a source of earth ground.

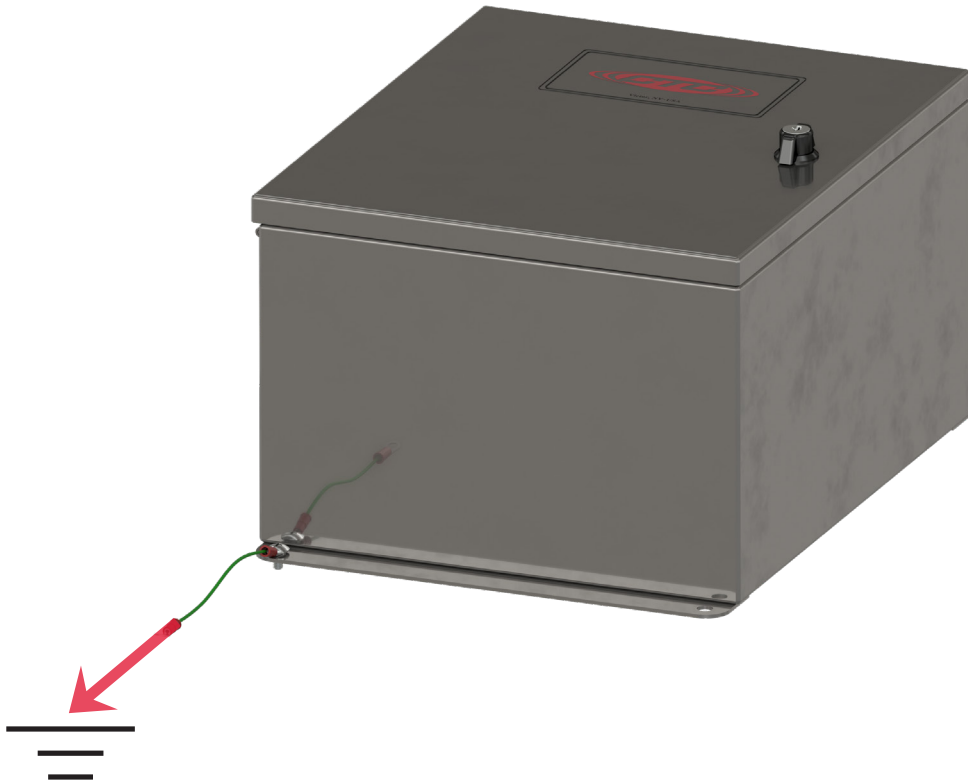

Figure 6. Ground Wire Placement

ELECTRICAL CONNECTONS

Cables enter and exit the enclosure through conduit fittings or cord grips on the bottom of the unit. All input and output wiring is connected to the terminal blocks and signal conditioners inside the unit. Inputs are routed through a conduit fitting or cord grips (1 per channel), output wiring is routed through a conduit fitting. 110 V_{ac} is needed to power the unit through the terminal on the right side of the enclosure. A ½ in. Conduit Fitting is provided for AC power entry.

Note: If utilizing cord grips for cable entry, ensure that all cord grip entries are used, or that unused grips are plugged. Empty cord grips provide a path for contaminates to leak into the enclosure and cause malfunctions.

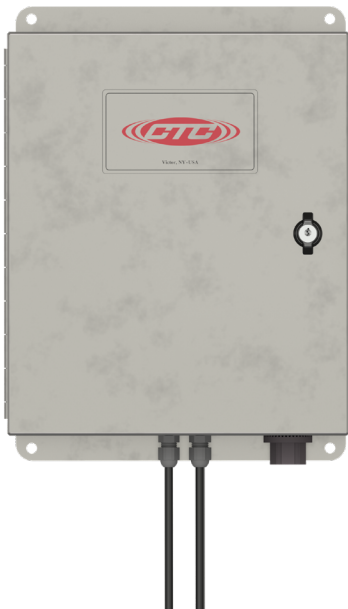

Figure 7. Front View

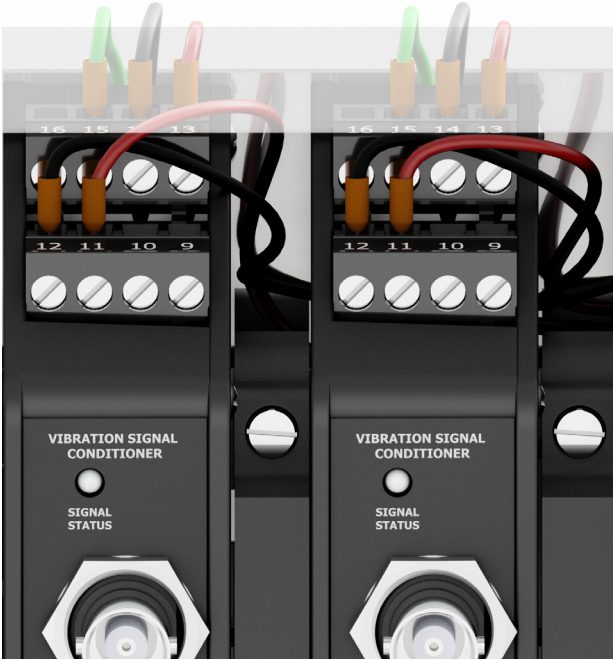

Figure 8. Bottom View

Wiring Inputs

Cables enter the enclosure through the designated entry option selected (cord grips or conduit or custom user defined/installed options). All wires are connected to terminal blocks within the enclosure. Sensor inputs for the SCE200 series are located on the right side of the enclosure as indicated by the interior labeling "Sensor Input."

Input for Vibration Data Only



Signal Conditioner Terminal Block Position	Four Pole Terminal Block Position	Cable Color	Destination
13	1	Red	Signal (+)
14	2	Black	Common
15	3	Green	Shield Drain

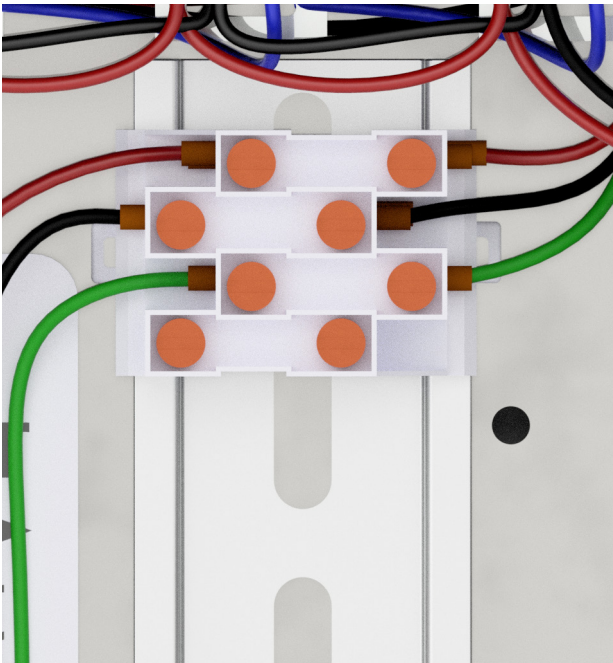

Input for Vibration and Temperature Data

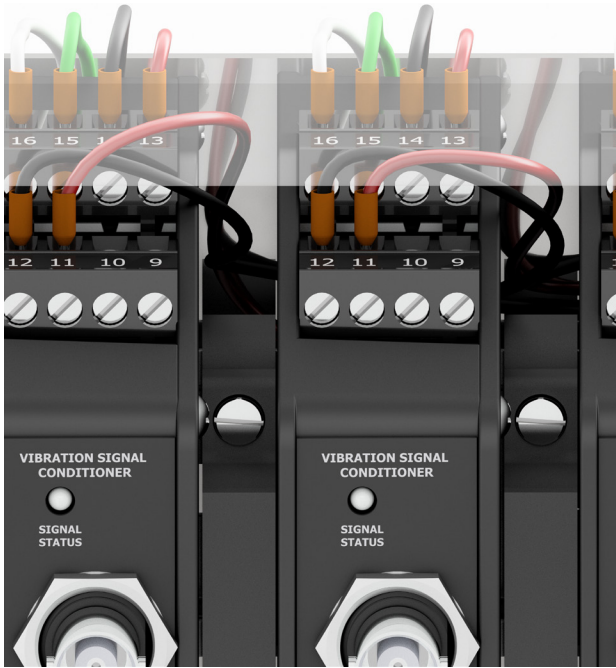

Signal Conditioner Terminal Block Position	Four Pole Terminal Block Position	Cable Color	Destination
13	1	Red	Signal (+)
14	2	Black	Common
15	3	Green	Shield Drain
16	4	White	Temperature

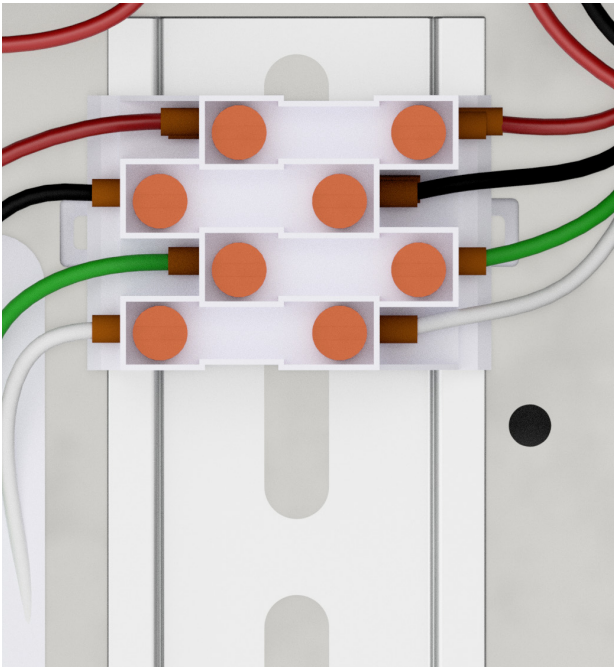

Note: If there is no sensor wired to the sensor input terminal, the corresponding transmitter for that channel will not power on. Be sure to power the system on **AFTER** the sensor has been connected.

Wiring Outputs

The 4-20mA output of the SCE200 series are located on the left side of the enclosure as indicated by the interior labeling "Output."

SCE211 — Signal Conditioners with Single Vibration Band Output

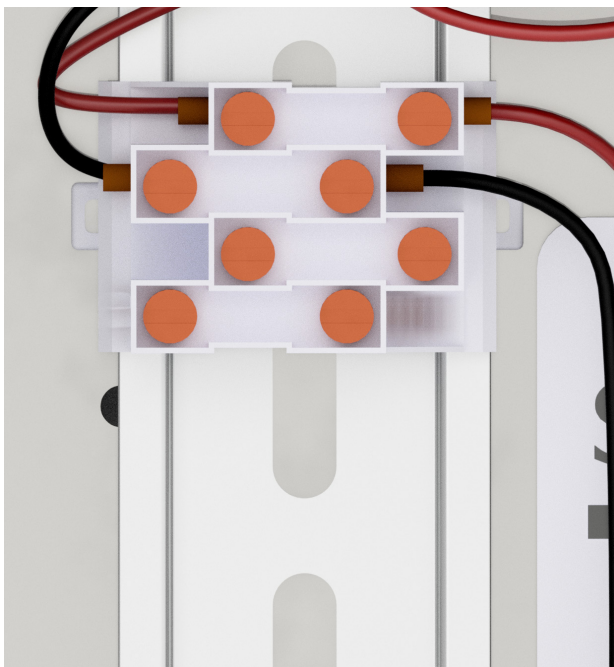
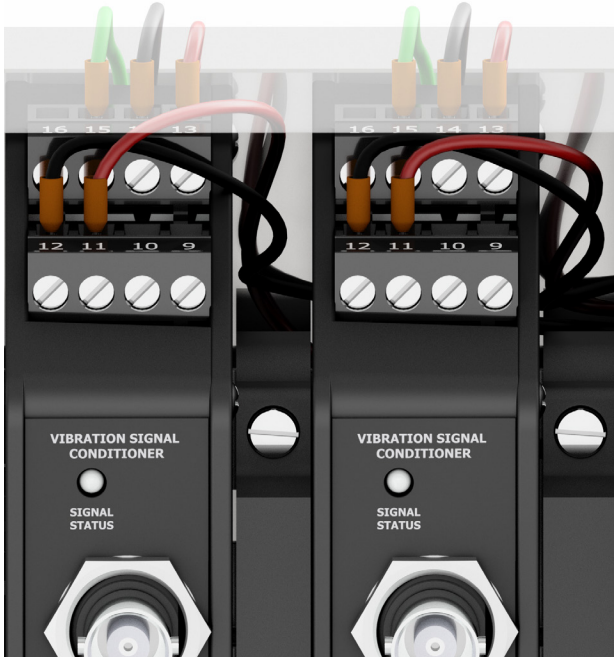

Signal Conditioner Terminal Block Position	Four Pole Terminal Block Position	Cable Color	Destination
11	1	Red	Channel 1 Output
12	2	Black	Common

SCE212 — Signal Conditioners with Single Vibration Band and Temperature Outputs

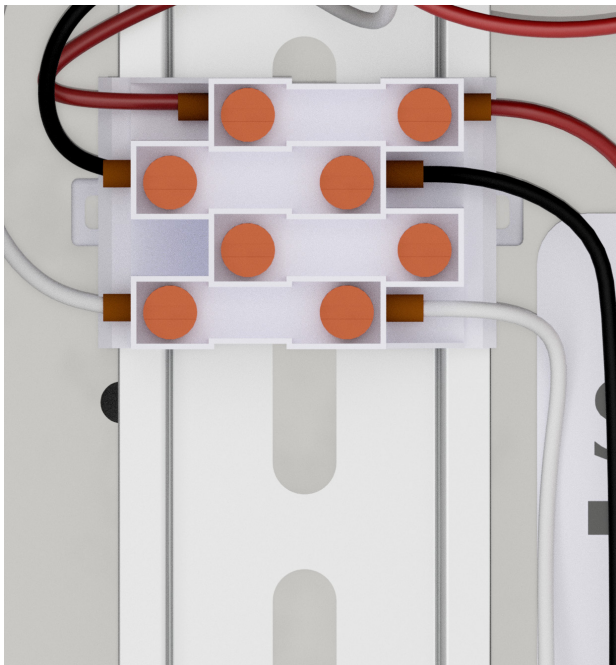
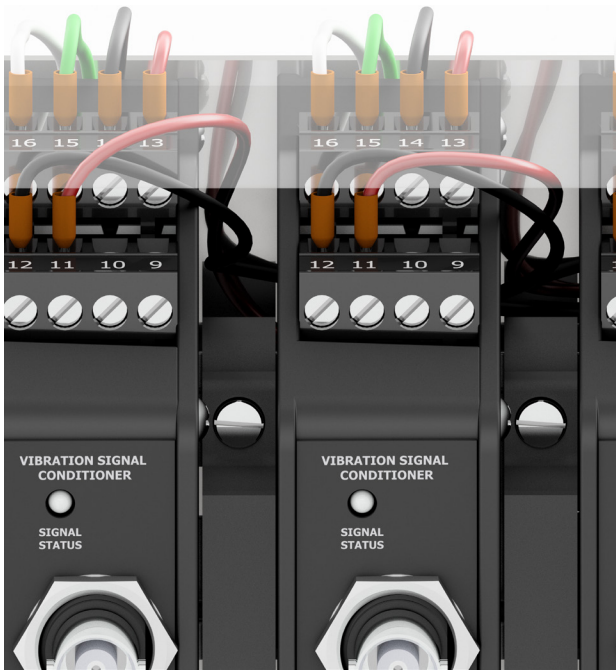

Signal Conditioner Terminal Block Position	Four Pole Terminal Block Position	Cable Color	Destination
11	1	Red	Channel 1 Output
12	2	Black	Common
1	4	White	Temperature Output

SCE213 — Signal Conditioners with Dual Vibration Band Output

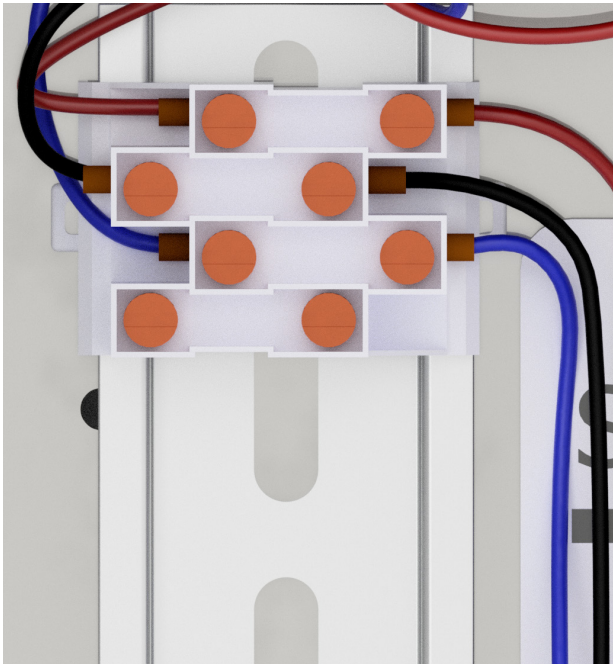

Signal Conditioner Terminal Block Position	Four Pole Terminal Block Position	Cable Color	Destination
11	1	Red	Channel 1 Output
12	2	Black	Common
7	3	Blue	Channel 2 Output

SCE214 — Signal Conditioners with Dual Vibration Band and Temperature Outputs

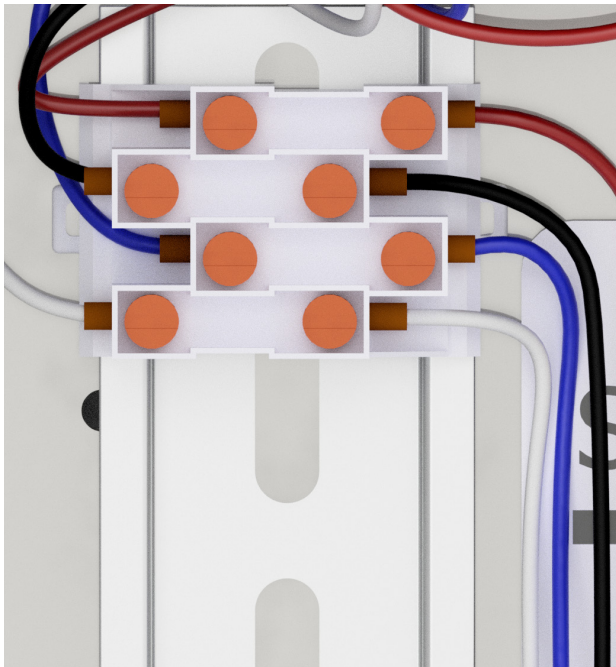
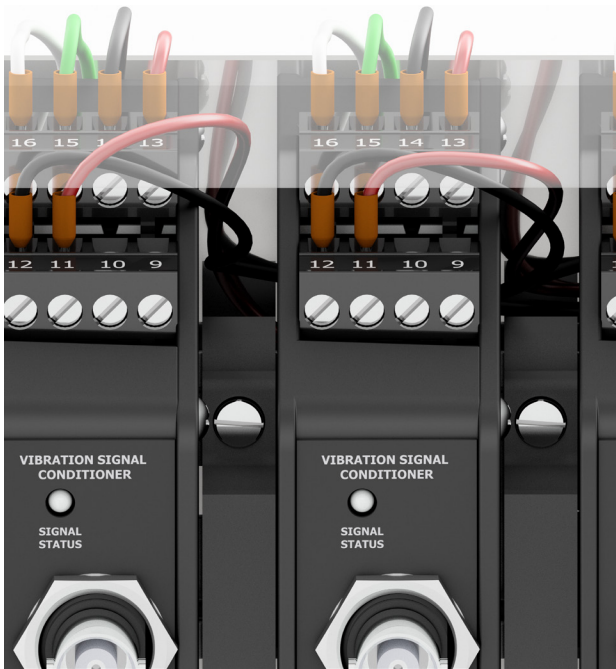

Signal Conditioner Terminal Block Position	Four Pole Terminal Block Position	Cable Color	Destination
11	1	Red	Channel 1 Output
12	2	Black	Common
7	3	Blue	Channel 2 Output
1	4	White	Temperature Output

Note: When collecting waveform data from the BNC jack on the signal conditioner using a portable data collector that supplies constant current power, it is recommended that the data collector is configured so that power to the sensor is turned off. Although the BNC connector circuitry offers short circuit protection and can safely sink the current, long-term degradation may occur due to increased power dissipation depending on the magnitude of the IEPE current. There is no need for the data collector sensor power to be turned on for the data collection to be made, and it is the safest way to make measurements if possible.

TROUBLESHOOTING

Signal Conditioner Configuration

Refer to the [SC310](#) and [SC320](#) Series Signal Conditioner Product Manuals for configuration specifications and procedure for SC310 and SC320 signal conditioners.

Once all wires are connected, apply power to begin operating the Signal Conditioner(s). Make sure the status light is indicating normal mode on each SC300.

Operating Procedure

To operate the Signal Conditioners inside the enclosure, make sure that all wires are properly connected, and then apply power.

Caution: Make sure that power input does not exceed specified limits or damage to the system may result. See Table 1.

Calibration

The signal conditioner is calibrated internally during startup. The digital calibration eliminates the need for any adjustments to the Analog Output.

Indicators

The LED on the front of the signal conditioner will indicate the status of the signal conditioner.

State 1 - Normal Operation

- LED is solid green

State 2 - Input Short Detected

- LED is rapidly flashing red



A short circuit is indicative of a lack of electrical resistance, removing the ability to measure the impact from a change in voltage. This instance is largely driven by an incorrect wiring setup. Verify that all wiring connections are attached in the correct polarity, and that no signal and common wires are touching. Lastly, ensure that the system is free of water and other contaminants.

State 3 - Input Open Detected

- LED is solid red

An open circuit implies a physical disconnect somewhere on the electrical path of the circuit. When receiving this error, verify that there is no physical separation within the system, such as unattached or broken cabling. Be sure that the connector is firmly secured to the accelerometer, and that the accelerometer is in good working order.

State 4 - Device Warning Detected

- LED is flashing green in 1-second intervals

A detected warning can be due to several things, such as incorrect output wiring (e.g., an open circuit detected on a current output or a short circuit detected on a voltage output) or corrupted configuration memory. The device will still be processing input data. However, it may be running in a reduced state or return unexpected results (e.g., if memory is corrupted, the unit will default to the standard ISO configuration until reprogrammed). If this state is detected, carefully inspect all wiring for secure connections and cycle power to the device. If the warning persists, the configurator can be used to determine the root cause and corrective action.

State 5 - Fatal Error

- LED is flashing red in 1-second intervals

In the case of a fatal error, the device has detected some non-recoverable hardware issue which could have been caused due to physical damage or misuse. Processing will be disabled in this case. Communication with the configurator may or may not work depending on the root cause but should be attempted as it may state the error that occurred. In some cases, cycling power to the device can remedy the issue.

State 6 - Programming & Startup

- LED is solid orange



This state occurs when the signal conditioner starts up, confirms there is an available configuration, and sets up its peripherals and outputs. If the USB cable is connected and plugged into a PC, this state will persist. Plugging in the USB cable at any point will also cause the device to enter this state. Regular operation will not occur while the USB cable is plugged in.

State 7 - Bootloader

- LED is flashing between red and green

This state occurs during device startup and indicates the bootloader is running. This state will persist if new firmware is being written for the duration of the update. If no firmware update handshake is received from the configurator within 5 seconds, the device leaves this state and continues with the startup.



WARRANTY & REFUND

Warranty

All CTC products are backed by our unconditional lifetime warranty. If any CTC product should ever fail, we will repair or replace it at no charge.

Refund

All stock products qualify for a full refund if returned in new condition within 90 days of shipment. Build to order products qualify for a 50% refund if returned in new condition within 90 days of shipment. Custom products are quoted and built specifically to the requirements of the customer, which may include completely custom product designs or private labeled versions of standard products for OEM customers. Custom products ordered are non-cancellable, non-returnable and non-refundable.

